



WLA

Grille



# Grille

WLA



## Description

WLA is an aluminum weather louvre fixed blades with pitch 25 mm, pitch 50 mm or pitch 100 mm suitable for air intake and exhaust air provided with protection net against birds or insects.

Optionally available with visible screw holes fixing or mounting frame.

Delivery as standard with bird net.

## Order code

Product	WLA	a	b	c	d	eee	x	fff	gggg
<b>Type</b>									
WLA									
<b>Frame</b>									
1 - 25 mm frame									
2 - 40 mm frame									
3 - 50 mm ramme									
<b>Grid</b>									
1 - 25 mm pitch				ONLY frame 1					
2 - 50 mm pitch				ONLY frame 2					
3 - 100 mm pitch				ONLY frame 3					
<b>Installation</b>									
- Not prepared									
C Clips				ONLY frame 1					
CM Clips + mounting frame				ONLY frame 1					
V Visible screw holes									
VM Visible screw holes + mounting frame									
<b>Accessories</b>									
- No accessories									
N Bird net									
I Insect net									
NI Bird net + insect net									
<b>Size</b>									
L: Min. 200 - max. 2000 mm									
H: Min.100 - max. 2050 mm									
See min. - max. dimension table									
<b>Grilles standard finish:</b>									
- Anodized aluminium									
9003 RAL 9003, gloss 30								ONLY frame 1 & 2	
xxxx On request, other RAL colour									

Example 1: WLA-11-CM-N-1000-200-9003

Example 2: WLA-22-V-I-1200-1000

## Min. - max. dimensions

WLA-11 (Only frame 1).

H \ L	200	↔	1200
100			
↓			
1200			

WLA-22 (Only frame 2).

H \ L	400	↔	2000
250			
↓			
2000			

WLA-33 (Only frame 3).

H \ L	400	↔	2000
250			
↓			
2050			

Standard grilles are available in steps of 50 mm within the above min. and max. sizes.

Customized sizes available on request.

Multiple parts assembly ( For frame 2 ):

L x B : 2001 - 4000 x 100 - 800 mm.

## Maintenance

The grille should be removed to gain access to the plenum box or duct. The external parts should be wiped with a damp cloth.

## Accessories

Bird net:	N
Insect net:	I
Mounting frame (For frame 1):	MFA
Mounting frame (For frame 2 and 3):	M

## Materials and finish

Grilles frame and blades:	Aluminium
Bird net:	Galvanized steel
Insect net:	Fiberglass
Mounting frame:	Galvanized steel

## Grilles standard finish:

- Anodized aluminium
- RAL 9003, gloss 30 (Frame 1 & 2)

The grille is available in other colours. Please contact Lindab's sales department for further information.

# Grille

# WLA

## Frame and grid

**WLA-11**, 25 mm frame - 25 mm pitch grid.

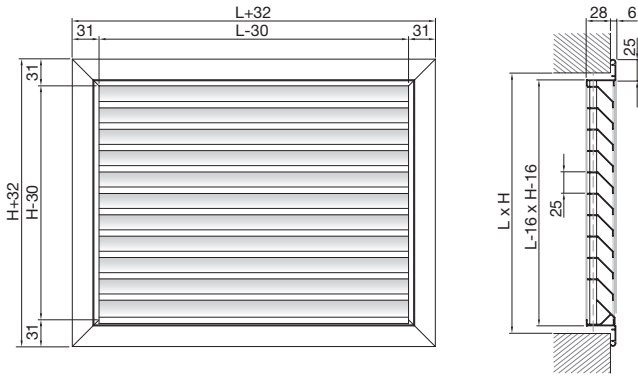

**WLA-22**, 40 mm frame - 50 mm pitch grid.

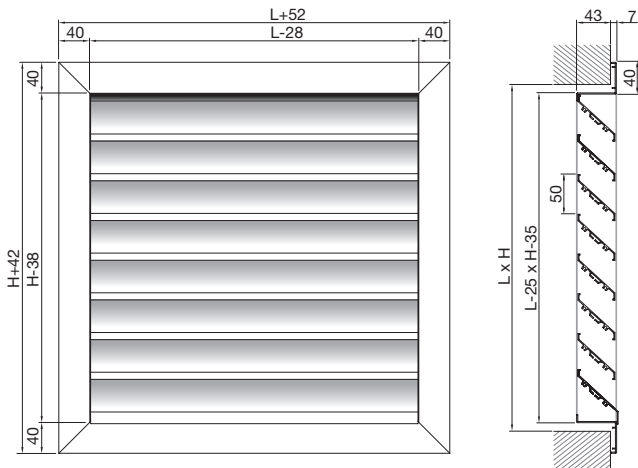

**WLA-33**, 50 mm frame - 100 mm pitch grid.

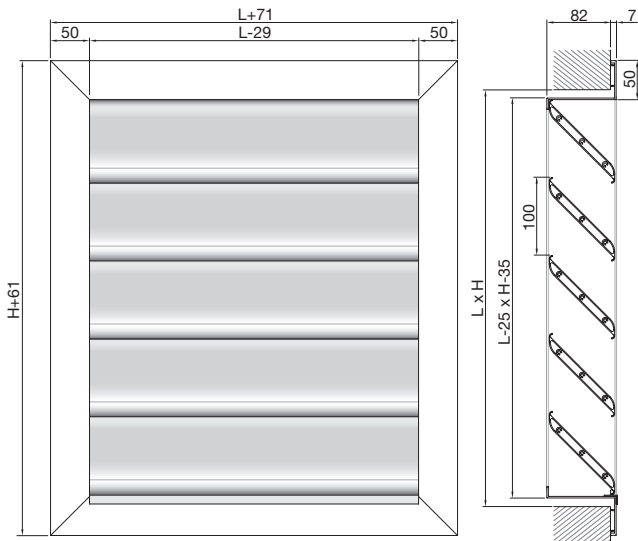

## Installation

- Not prepared

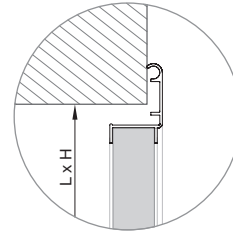

**C - Clips**  
**CM - Clips + mounting frame**

C and CM solution only available for 25 mm Frame (11).

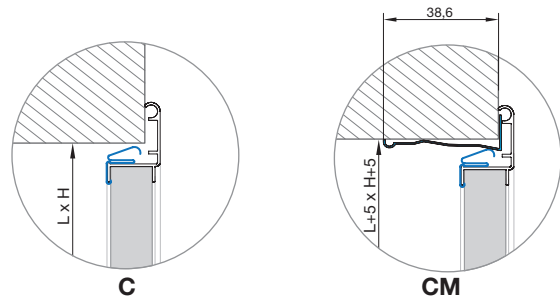

**V \* - Visible screw holes**  
**VM \* - Visible screw holes + mounting frame**

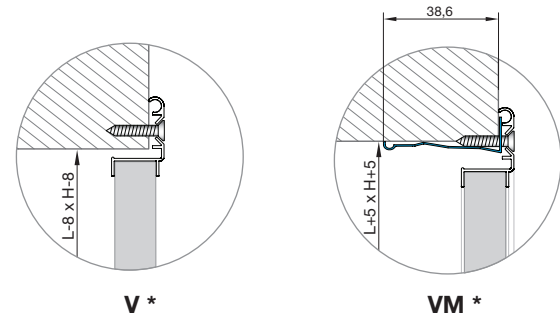

\* Screws are not included  
\*\* VM illustration shows frame 1 (25 mm) and MFA mounting frame.  
The mounting frame M for frame types 2 (40 mm) and 3 (50 mm) has a different shape.

# Grille

# WLA

## Free area

H / L	WLA-11 External louvre, pitch 25 mm												
	A <sub>k</sub> [m <sup>2</sup> ]												
	200	250	300	350	400	450	500	550	600	700	800	900	1000
100	0.006	0.008	0.009	0.011	0.013	0.015	0.016	0.018	0.020	0.023	0.027	0.030	0.034
150	0.012	0.015	0.019	0.022	0.026	0.029	0.033	0.036	0.040	0.047	0.054	0.061	0.068
200	0.018	0.023	0.028	0.034	0.039	0.044	0.049	0.055	0.060	0.070	0.081	0.091	0.102
250	0.024	0.031	0.038	0.045	0.052	0.059	0.066	0.073	0.080	0.094	0.108	0.122	0.136
300	0.030	0.038	0.047	0.056	0.065	0.073	0.082	0.091	0.100	0.117	0.135	0.152	0.170
350	0.036	0.046	0.057	0.067	0.078	0.088	0.099	0.109	0.120	0.141	0.162	0.183	0.204
400	0.042	0.054	0.066	0.078	0.091	0.103	0.115	0.127	0.140	0.164	0.189	0.213	0.238
450	0.048	0.062	0.076	0.090	0.104	0.118	0.132	0.146	0.160	0.188	0.216	0.244	0.272
500	0.054	0.069	0.085	0.101	0.117	0.132	0.148	0.164	0.180	0.211	0.243	0.274	0.305
550	0.059	0.077	0.094	0.112	0.129	0.147	0.164	0.182	0.199	0.234	0.269	0.304	0.339
600	0.065	0.085	0.104	0.123	0.142	0.162	0.181	0.200	0.219	0.258	0.296	0.335	0.373
700	0.077	0.100	0.123	0.146	0.168	0.191	0.214	0.237	0.259	0.305	0.350	0.396	0.441
800	0.089	0.115	0.142	0.168	0.194	0.220	0.247	0.273	0.299	0.352	0.404	0.457	0.509
900	0.101	0.131	0.161	0.190	0.220	0.250	0.280	0.309	0.339	0.399	0.458	0.518	0.577
1000	0.113	0.146	0.180	0.213	0.246	0.279	0.312	0.346	0.379	0.445	0.512	0.578	0.645

H / L	WLA-22 External louvre, pitch 50 mm											
	A <sub>k</sub> [m <sup>2</sup> ]											
	400	450	500	550	600	650	700	750	800	850	900	1000
250	0.028	0.032	0.036	0.040	0.044	0.048	0.052	0.056	0.060	0.064	0.068	0.076
300	0.037	0.043	0.048	0.053	0.058	0.064	0.069	0.074	0.079	0.085	0.090	0.100
400	0.055	0.063	0.071	0.078	0.086	0.094	0.102	0.109	0.117	0.125	0.133	0.148
450	0.064	0.073	0.082	0.091	0.100	0.109	0.118	0.127	0.136	0.145	0.154	0.172
500	0.073	0.083	0.093	0.104	0.114	0.124	0.134	0.145	0.155	0.165	0.175	0.196
550	0.082	0.093	0.105	0.116	0.128	0.139	0.151	0.162	0.174	0.185	0.197	0.220
600	0.091	0.103	0.116	0.129	0.142	0.154	0.167	0.180	0.193	0.205	0.218	0.244
650	0.099	0.113	0.127	0.141	0.155	0.169	0.183	0.197	0.211	0.225	0.239	0.267
700	0.108	0.124	0.139	0.154	0.169	0.185	0.200	0.215	0.230	0.246	0.261	0.291
750	0.117	0.134	0.150	0.167	0.183	0.200	0.216	0.233	0.249	0.266	0.282	0.315
800	0.126	0.144	0.162	0.179	0.197	0.215	0.233	0.250	0.268	0.286	0.304	0.339
850	0.135	0.154	0.173	0.192	0.211	0.230	0.249	0.268	0.287	0.306	0.325	0.363
900	0.144	0.164	0.184	0.205	0.225	0.245	0.265	0.286	0.306	0.326	0.346	0.387
950	0.153	0.174	0.196	0.217	0.239	0.260	0.282	0.303	0.325	0.346	0.368	0.411
1000	0.162	0.184	0.207	0.230	0.253	0.275	0.298	0.321	0.344	0.366	0.389	0.435

H / L	WLA-33 External louvre, pitch 100 mm										
	A <sub>k</sub> [m <sup>2</sup> ]										
	400	450	500	550	600	650	700	750	800	900	1000
250	0.021	0.024	0.027	0.030	0.033	0.036	0.039	0.042	0.045	0.051	0.056
350	0.039	0.045	0.051	0.056	0.062	0.068	0.074	0.079	0.085	0.096	0.108
450	0.058	0.067	0.075	0.083	0.092	0.100	0.109	0.117	0.125	0.142	0.159
550	0.077	0.088	0.099	0.110	0.121	0.133	0.144	0.155	0.166	0.188	0.211
650	0.096	0.109	0.123	0.137	0.151	0.165	0.179	0.193	0.206	0.234	0.262
850	0.133	0.152	0.172	0.191	0.210	0.230	0.249	0.268	0.287	0.326	0.365
1050	0.171	0.195	0.220	0.245	0.269	0.294	0.319	0.344	0.368	0.418	0.467
1250	0.208	0.238	0.268	0.299	0.329	0.359	0.389	0.419	0.449	0.510	0.570
1450	0.246	0.281	0.317	0.352	0.388	0.424	0.459	0.495	0.530	0.602	0.673
1850	0.321	0.367	0.414	0.460	0.506	0.553	0.599	0.646	0.692	0.785	0.878
2050	0.358	0.410	0.462	0.514	0.566	0.618	0.669	0.721	0.773	0.877	0.981

# Grille



## Quick selection, Air intake, WLA-11

Grille size [mm]		A <sub>k</sub> [m²]	Air flow rate																				
			m³/h	300	550	700	850	1000	1200	1500	1800	2000	2500	2800	3000	3500	3800	4000	4500	5000	5500		
			I/s	(83)	(153)	(194)	(236)	(278)	(333)	(417)	(500)	(556)	(694)	(778)	(833)	(972)	(1056)	(1111)	(1250)	(1389)	(1528)		
H=200	500x200 (0,049)	L <sub>WA</sub> [dB(A)] V <sub>k</sub> [m/s] Δp <sub>t</sub> [Pa]	21 1,7 5	38 3,1 16	45 3,9 25																		
	600x200 (0,06)	L <sub>WA</sub> [dB(A)] V <sub>k</sub> [m/s] Δp <sub>t</sub> [Pa]	<20 1,4 3	34 2,6 11	41 3,2 17	46 3,9 26																	
	800x200 (0,081)	L <sub>WA</sub> [dB(A)] V <sub>k</sub> [m/s] Δp <sub>t</sub> [Pa]		27 1,9 6	34 2,4 9	39 2,9 14	44 3,4 19	49 4,1 28															
H=300	300x300 (0,047)	L <sub>WA</sub> [dB(A)] V <sub>k</sub> [m/s] Δp <sub>t</sub> [Pa]	22 1,8 5	39 3,2 17	46 4,1 28																		
	500x300 (0,082)	L <sub>WA</sub> [dB(A)] V <sub>k</sub> [m/s] Δp <sub>t</sub> [Pa]		26 1,9 6	33 2,4 9	39 2,9 14	44 3,4 19	49 4 27															
	600x300 (0,1)	L <sub>WA</sub> [dB(A)] V <sub>k</sub> [m/s] Δp <sub>t</sub> [Pa]		22 1,5 4	29 1,9 6	34 2,4 9	39 2,8 13	44 3,3 18															
	800x300 (0,135)	L <sub>WA</sub> [dB(A)] V <sub>k</sub> [m/s] Δp <sub>t</sub> [Pa]		<20 1,1 2	21 1,4 3	27 1,8 5	32 2,1 7	37 2,5 10	44 3,1 16	49 3,7 23													
H=400	400x400 (0,091)	L <sub>WA</sub> [dB(A)] V <sub>k</sub> [m/s] Δp <sub>t</sub> [Pa]		24 1,7 5	31 2,1 8	37 2,6 11	41 3,1 15	47 3,7 22															
	600x400 (0,14)	L <sub>WA</sub> [dB(A)] V <sub>k</sub> [m/s] Δp <sub>t</sub> [Pa]		<20 1,1 2	21 1,4 3	26 1,7 5	31 2 7	36 2,4 9	43 3 15	48 3,6 21													
	800x400 (0,189)	L <sub>WA</sub> [dB(A)] V <sub>k</sub> [m/s] Δp <sub>t</sub> [Pa]		<20 1 2	<20 1,3 3	25 1,5 4	30 1,8 5	35 2,2 8	42 2,7 12	47 2,9 14													
	500x500 (0,148)	L <sub>WA</sub> [dB(A)] V <sub>k</sub> [m/s] Δp <sub>t</sub> [Pa]		<20 1 2	<20 1,3 3	25 1,6 4	30 1,9 6	35 2,2 8	42 2,8 13	47 3,4 19	50 3,8 23												
H=500	600x500 (0,18)	L <sub>WA</sub> [dB(A)] V <sub>k</sub> [m/s] Δp <sub>t</sub> [Pa]		<20 1,1 2	<20 1,3 3	20 1,5 4	25 1,9 6	30 2,3 9	37 2,8 13	42 3,1 16													
	800x500 (0,243)	L <sub>WA</sub> [dB(A)] V <sub>k</sub> [m/s] Δp <sub>t</sub> [Pa]		<20 1 2	<20 1,1 2	23 1,4 3	30 1,7 5	35 2,1 7	38 2,3 9	45 2,9 13	48 3,2 17	50 3,4 19											
	600x600 (0,219)	L <sub>WA</sub> [dB(A)] V <sub>k</sub> [m/s] Δp <sub>t</sub> [Pa]		<20 0,9 1	<20 1,1 2	20 1,3 3	26 1,5 4	32 1,9 6	38 2,3 9	41 2,5 11	47 3,2 16												
H=600	800x600 (0,296)	L <sub>WA</sub> [dB(A)] V <sub>k</sub> [m/s] Δp <sub>t</sub> [Pa]		<20 0,9 1	<20 1,1 2	25 1,4 3	30 1,7 5	34 1,9 6	40 2,3 9	43 2,6 11	45 2,8 13	50 3,3 18											
	1000x600 (0,373)	L <sub>WA</sub> [dB(A)] V <sub>k</sub> [m/s] Δp <sub>t</sub> [Pa]		<20 0,9 1	20 1,1 2	25 1,3 3	28 1,5 4	35 1,9 6	38 2,1 7	40 2,2 8	47 2,8 13	48 3 15											
	1200x600 (0,45)	L <sub>WA</sub> [dB(A)] V <sub>k</sub> [m/s] Δp <sub>t</sub> [Pa]		<20 0,9 1	21 1,1 2	24 1,2 3	30 1,5 4	33 1,7 5	35 1,8 6	40 2,2 8	42 2,5 10	44 2,8 13	47 3,1 16										
	1000x800 (0,509)	L <sub>WA</sub> [dB(A)] V <sub>k</sub> [m/s] Δp <sub>t</sub> [Pa]		<20 0,8 1	<20 1 2	21 1,1 2	27 1,4 3	31 1,6 4	33 1,9 6	37 2,1 8	39 2,2 10	41 2,5 12	44 2,7 15	48 3 18									
H=800	1200x800 (0,614)	L <sub>WA</sub> [dB(A)] V <sub>k</sub> [m/s] Δp <sub>t</sub> [Pa]		<20 0,8 1	<20 0,9 1	23 1,1 2	28 1,3 3	33 1,4 4	35 1,6 5	37 1,7 6	39 1,8 8	41 2 10	43 2,3 13	46 2,5 16									
	1500x800 (0,772)	L <sub>WA</sub> [dB(A)] V <sub>k</sub> [m/s] Δp <sub>t</sub> [Pa]		<20 0,7 1	<20 0,9 1	21 1 2	23 1,1 2	27 1,3 3	30 1,4 4	31 1,4 5	33 1,6 6	35 1,8 8	38 2 10	40 2,2 13									
	1000x800 (0,509)	L <sub>WA</sub> [dB(A)] V <sub>k</sub> [m/s] Δp <sub>t</sub> [Pa]		<20 0,7 1	<20 0,9 1	21 1 2	23 1,1 2	27 1,3 3	30 1,4 4	31 1,4 5	33 1,6 6	35 1,8 8	38 2 10	40 2,2 13									

10 ≤ LWA < 30    30 ≤ LWA < 40    40 ≤ LWA < 50

### Data valid for:

- Air intake

### Terminology:

- A<sub>k</sub> = effective free area
- v<sub>k</sub> = effective face velocity
- Δp<sub>t</sub> = total pressure loss
- L<sub>WA</sub> = sound power level

## Quick selection, Air intake, WLA-22

Grille size [mm]		Air flow rate																					
A <sub>k</sub> [m <sup>2</sup> ]	m <sup>3</sup> /h	l/s																					
		(139)	(194)	(222)	(278)	(333)	(417)	(556)	(694)	(833)	(972)	(1111)	(1250)	(1389)	(1667)	(1944)	(2500)	(3333)	(5000)				
H=400	400x400 (0,055)	L <sub>WA</sub> [dB(A)]	20	28	31	37	41	47															
		V <sub>k</sub> [m/s]	2,5	3,5	4	5,1	6,1	7,6															
		Δp <sub>t</sub> [Pa]	5	10	14	21	31	48															
	500x400 (0,071)	L <sub>WA</sub> [dB(A)]	<20	23	27	32	37	42	50														
		V <sub>k</sub> [m/s]	2	2,8	3,1	3,9	4,7	5,9	7,9														
		Δp <sub>t</sub> [Pa]	3	6	8	13	19	29	52														
	600x400 (0,086)	L <sub>WA</sub> [dB(A)]	<20	<20	23	28	33	39	46														
		V <sub>k</sub> [m/s]	1,6	2,3	2,6	3,2	3,9	4,8	6,5														
		Δp <sub>t</sub> [Pa]	2	4	6	9	13	20	35														
	800x400 (0,117)	L <sub>WA</sub> [dB(A)]		<20	<20	23	27	33	40	45	50												
V <sub>k</sub> [m/s]			1,7	1,9	2,4	2,8	3,6	4,8	5,9	7,1													
Δp <sub>t</sub> [Pa]			2	3	5	7	11	19	30	43													
1000x400 (0,148)	L <sub>WA</sub> [dB(A)]			<20	<20	23	28	35	41	46	49												
	V <sub>k</sub> [m/s]			1,5	1,9	2,2	2,8	3,8	4,7	5,6	6,6												
	Δp <sub>t</sub> [Pa]			2	3	4	7	12	18	27	36												
H=500	500x500 (0,093)	L <sub>WA</sub> [dB(A)]	<20	<20	21	27	31	37	44	50													
		V <sub>k</sub> [m/s]	1,5	2,1	2,4	3	3,6	4,5	6	7,4													
		Δp <sub>t</sub> [Pa]	2	4	5	7	11	17	30	46													
	600x500 (0,114)	L <sub>WA</sub> [dB(A)]		<20	<20	23	28	33	40	46													
		V <sub>k</sub> [m/s]		1,7	2	2,4	2,9	3,7	4,9	6,1													
		Δp <sub>t</sub> [Pa]		2	3	5	7	11	20	31													
	800x500 (0,155)	L <sub>WA</sub> [dB(A)]			<20	<20	22	27	35	40	45	49											
		V <sub>k</sub> [m/s]			1,4	1,8	2,2	2,7	3,6	4,5	5,4	6,3											
		Δp <sub>t</sub> [Pa]			2	3	4	6	11	17	24	33											
	1000x500 (0,196)	L <sub>WA</sub> [dB(A)]				<20	<20	23	30	36	40	44	47	50									
V <sub>k</sub> [m/s]					1,4	1,7	2,1	2,8	3,5	4,3	5	5,7	6,4										
Δp <sub>t</sub> [Pa]					2	2	4	7	11	15	21	27	34										
H=600	600x600 (0,142)	L <sub>WA</sub> [dB(A)]		<20	<20	<20	23	29	36	42	46	50											
		V <sub>k</sub> [m/s]		1,4	1,6	2	2,4	2,9	3,9	4,9	5,9	6,9											
		Δp <sub>t</sub> [Pa]		2	2	3	5	7	13	20	29	40											
	800x600 (0,193)	L <sub>WA</sub> [dB(A)]				<20	<20	23	30	36	41	44	48										
		V <sub>k</sub> [m/s]				1,4	1,7	2,2	2,9	3,6	4,3	5	5,8										
		Δp <sub>t</sub> [Pa]				2	3	4	7	11	16	21	28										
	1000x600 (0,244)	L <sub>WA</sub> [dB(A)]					<20	<20	26	32	36	40	43	46	49								
		V <sub>k</sub> [m/s]					1,4	1,7	2,3	2,8	3,4	4	4,6	5,1	5,7								
		Δp <sub>t</sub> [Pa]					2	2	4	7	10	13	17	22	27								
	1200x600 (0,295)	L <sub>WA</sub> [dB(A)]					<20	<20	22	28	32	36	40	43	45	50							
V <sub>k</sub> [m/s]						1,1	1,4	1,9	2,4	2,8	3,3	3,8	4,2	4,7	5,7								
Δp <sub>t</sub> [Pa]						1	2	3	5	7	9	12	15	19	27								
H=800	800x800 (0,268)	L <sub>WA</sub> [dB(A)]					<20	<20	24	30	34	38	41	44	47								
		V <sub>k</sub> [m/s]					1,2	1,6	2,1	2,6	3,1	3,6	4,1	4,7	5,2								
		Δp <sub>t</sub> [Pa]					1	2	4	6	8	11	14	18	23								
	1000x800 (0,339)	L <sub>WA</sub> [dB(A)]						<20	20	25	30	34	37	40	43	47							
		V <sub>k</sub> [m/s]						1,2	1,6	2	2,5	2,9	3,3	3,7	4,1	4,9							
		Δp <sub>t</sub> [Pa]						1	2	4	5	7	9	11	14	20							
	1200x800 (0,41)	L <sub>WA</sub> [dB(A)]							<20	22	26	30	33	36	39	43	47						
		V <sub>k</sub> [m/s]							1,4	1,7	2	2,4	2,7	3	3,4	4,1	4,7						
		Δp <sub>t</sub> [Pa]							2	2	3	5	6	8	10	14	19						
	1500x800 (0,517)	L <sub>WA</sub> [dB(A)]							<20	<20	22	26	29	32	35	39	43	49					
V <sub>k</sub> [m/s]								1,1	1,3	1,6	1,9	2,2	2,4	2,7	3,2	3,8	4,8						
Δp <sub>t</sub> [Pa]								1	2	2	3	4	5	6	9	12	20						
1800x800 (0,623)	L <sub>WA</sub> [dB(A)]								<20	<20	22	25	28	31	36	39	46						
	V <sub>k</sub> [m/s]								1,1	1,3	1,6	1,8	2	2,2	2,7	3,1	4						
	Δp <sub>t</sub> [Pa]								1	2	2	3	3	4	6	8	14						
2000x800 (0,694)	L <sub>WA</sub> [dB(A)]									<20	<20	20	23	26	29	33	37	44					
	V <sub>k</sub> [m/s]									1	1,2	1,4	1,6	1,8	2	2,4	2,8	3,6					
	Δp <sub>t</sub> [Pa]									1	1	2	2	3	3	5	7	11					
H=1000	1000x1000 (0,435)	L <sub>WA</sub> [dB(A)]							<20	21	25	29	32	35	38	42	46						
		V <sub>k</sub> [m/s]								1,3	1,6	1,9	2,2	2,6	2,9	3,2	3,8	4,5					
H=1200	1200x1200 (0,641)	L <sub>WA</sub> [dB(A)]								<20	<20	22	25	28	30	35	39	45					
		V <sub>k</sub> [m/s]									1,1	1,3	1,5	1,7	2	2,2	2,6	3	3,9				
H=1500	1500x1500 (1,026)	L <sub>WA</sub> [dB(A)]										<20	<20	<20	22	26	30	36	43				
		V <sub>k</sub> [m/s]											0,9	1,1	1,2	1,4	1,6	1,9	2,4	3,2			
H=2000	2000x2000 (1,867)	L <sub>WA</sub> [dB(A)]														<20	<20	<20	25	32	42		
		V <sub>k</sub> [m/s]															0,7	0,9	1	1,3	1,8	2,7	
		Δp <sub>t</sub> [Pa]														0	1	1	2	3	6		

10 ≤ L<sub>WA</sub> < 30    30 ≤ L<sub>WA</sub> < 40    40 ≤ L<sub>WA</sub> < 50

### Data valid for:

- Air intake

### Terminology:

- A<sub>k</sub> = effective free area
- v<sub>k</sub> = effective face velocity
- Δp<sub>t</sub> = total pressure loss
- L<sub>WA</sub> = sound power level

# Grille



## Quick selection, Air intake, WLA-33

Grille size [mm]		Air flow rate																		
		m³/h	700	800	1000	1500	2000	2500	3000	3500	4000	5000	8000	10000	12000	16000	18000	25000	28000	30000
A <sub>k</sub> [m²]	l/s	(194)	(222)	(278)	(417)	(556)	(694)	(833)	(972)	(1111)	(1389)	(2222)	(2778)	(3333)	(4444)	(5000)	(6944)	(7778)	(8333)	
H=350	L <sub>WA</sub> [dB(A)]	21	25	32	45															
	V <sub>k</sub> [m/s]	4,9	5,6	7,1	10,6															
	Δp <sub>t</sub> [Pa]	9	11	18	40															
	L <sub>WA</sub> [dB(A)]	<20	<20	26	39	48														
	V <sub>k</sub> [m/s]	3,8	4,4	5,5	8,2	10,9														
	Δp <sub>t</sub> [Pa]	6	7	11	26	46														
H=450	L <sub>WA</sub> [dB(A)]	<20	<20	21	34	43	50													
	V <sub>k</sub> [m/s]	3,1	3,6	4,5	6,7	8,9	11,2													
	Δp <sub>t</sub> [Pa]	4	5	8	18	32	50													
	L <sub>WA</sub> [dB(A)]			<20	26	35	42	48												
	V <sub>k</sub> [m/s]			3,3	4,9	6,5	8,2	9,8												
	Δp <sub>t</sub> [Pa]			4	10	18	28	40												
H=550	L <sub>WA</sub> [dB(A)]				20	29	36	42	46											
	V <sub>k</sub> [m/s]				3,9	5,2	6,4	7,7	9											
	Δp <sub>t</sub> [Pa]				6	11	18	26	35											
	L <sub>WA</sub> [dB(A)]			<20	27	36	43	49												
	V <sub>k</sub> [m/s]			3	4,5	6,1	7,6	9,1												
	Δp <sub>t</sub> [Pa]			4	11	19	30	43												
H=750	L <sub>WA</sub> [dB(A)]				<20	28	35	41	46	50										
	V <sub>k</sub> [m/s]				3,3	4,4	5,5	6,6	7,7	8,9										
	Δp <sub>t</sub> [Pa]				6	11	17	24	33	43										
	L <sub>WA</sub> [dB(A)]				<20	22	29	35	40	44										
	V <sub>k</sub> [m/s]				2,6	3,5	4,4	5,2	6,1	7										
	Δp <sub>t</sub> [Pa]				4	7	11	16	21	28										
H=950	L <sub>WA</sub> [dB(A)]				21	30	37	43	48											
	V <sub>k</sub> [m/s]				3,4	4,6	5,7	6,9	8											
	Δp <sub>t</sub> [Pa]				7	13	20	29	39											
	L <sub>WA</sub> [dB(A)]				<20	23	30	35	40	44										
	V <sub>k</sub> [m/s]				2,5	3,3	4,2	5	5,9	6,7										
	Δp <sub>t</sub> [Pa]				4	7	11	16	22	29										
H=1150	L <sub>WA</sub> [dB(A)]				<20	24	29	34	38	45										
	V <sub>k</sub> [m/s]				2,6	3,3	4	4,6	5,3	6,6										
	Δp <sub>t</sub> [Pa]				5	7	10	14	19	29										
	L <sub>WA</sub> [dB(A)]				<20	<20	24	29	33	40										
	V <sub>k</sub> [m/s]				2,2	2,7	3,3	3,8	4,4	5,4										
	Δp <sub>t</sub> [Pa]				3	5	7	10	13	20										
H=1450	L <sub>WA</sub> [dB(A)]				<20	21	27	32	36	43										
	V <sub>k</sub> [m/s]				2,3	2,8	3,4	3,9	4,5	5,6										
	Δp <sub>t</sub> [Pa]				4	6	9	12	16	24										
	L <sub>WA</sub> [dB(A)]				<20	21	26	30	37											
	V <sub>k</sub> [m/s]				2,2	2,7	3,1	3,5	4,4											
	Δp <sub>t</sub> [Pa]				4	6	8	10	16											
H=1960	L <sub>WA</sub> [dB(A)]						<20	<20	21	25	32	47								
	V <sub>k</sub> [m/s]						1,8	2,2	2,6	2,9	3,7	5,9								
	Δp <sub>t</sub> [Pa]						3	4	5	7	11	28								
	L <sub>WA</sub> [dB(A)]						<20	<20	<20	26	41	48								
	V <sub>k</sub> [m/s]						1,7	2	2,3	2,9	4,6	5,8								
	Δp <sub>t</sub> [Pa]						2	3	4	7	18	28								
H=2000	L <sub>WA</sub> [dB(A)]							<20	<20	21	36	43	49							
	V <sub>k</sub> [m/s]							1,7	1,9	2,4	3,8	4,8	5,8							
	Δp <sub>t</sub> [Pa]							2	3	5	12	19	28							
	L <sub>WA</sub> [dB(A)]							<20	<20	33	40	46								
	V <sub>k</sub> [m/s]							1,7	2,2	3,4	4,3	5,2								
	Δp <sub>t</sub> [Pa]							2	4	10	16	22								
H=1960	L <sub>WA</sub> [dB(A)]									<20	20	29	33	43	47					
	V <sub>k</sub> [m/s]									1,5	1,7	2,3	2,6	3,6	4,1	4,4				
	Δp <sub>t</sub> [Pa]									2	3	6	7	14	18	21				

10 ≤ L<sub>WA</sub> < 30    30 ≤ L<sub>WA</sub> < 40    40 ≤ L<sub>WA</sub> < 50

### Data valid for:

- Air intake

### Terminology:

- A<sub>k</sub> = effective free area
- v<sub>k</sub> = effective face velocity
- Δp<sub>t</sub> = total pressure loss
- L<sub>WA</sub> = sound power level

# Grille

WLA

## Technical data

### Capacity

Air flow rate  $q_v$  [l/s] and [m<sup>3</sup>/h], total pressure loss  $\Delta p_t$  [Pa], throw  $l_{0,2}$  [m] and sound power level  $L_{WA}$  [dB(A)] can be seen in the diagrams.

### Sound pressure level in free field (1/4 spherical)

Sound power level  $L_{WA}$  [dB(A)] can be seen in the diagrams. The sound power levels apply for grilles without an opposed blade damper.

For sound pressure level at distance X [m]:

$$L_{pA} = L_{WA} - K, \text{ see table below}$$

X [m]	1	2	3	4	5	-13	20
K [dB(A)]	-5	-12	-15	-17	-19	-25	-30

### Frequency-related sound power level

The sound power level in the frequency band is defined as

$$L_{Wf} = L_{WA} + K_{ok}$$

$K_{ok}$  values are given in the table below.

	Centre frequency Hz							
	63	125	250	500	1K	2K	4K	8K
Air intake	-4	-3	1	-5	-14	-19	-20	-17
Air outlet	-10	-2	3	-3	-9	-11	-16	-22

### Air outlet

Total pressure loss $\Delta p_t$	x 0.78
Sound power level $L_{WA}$	- 2



# Grille

# WLA

## Technical data, WLA-11

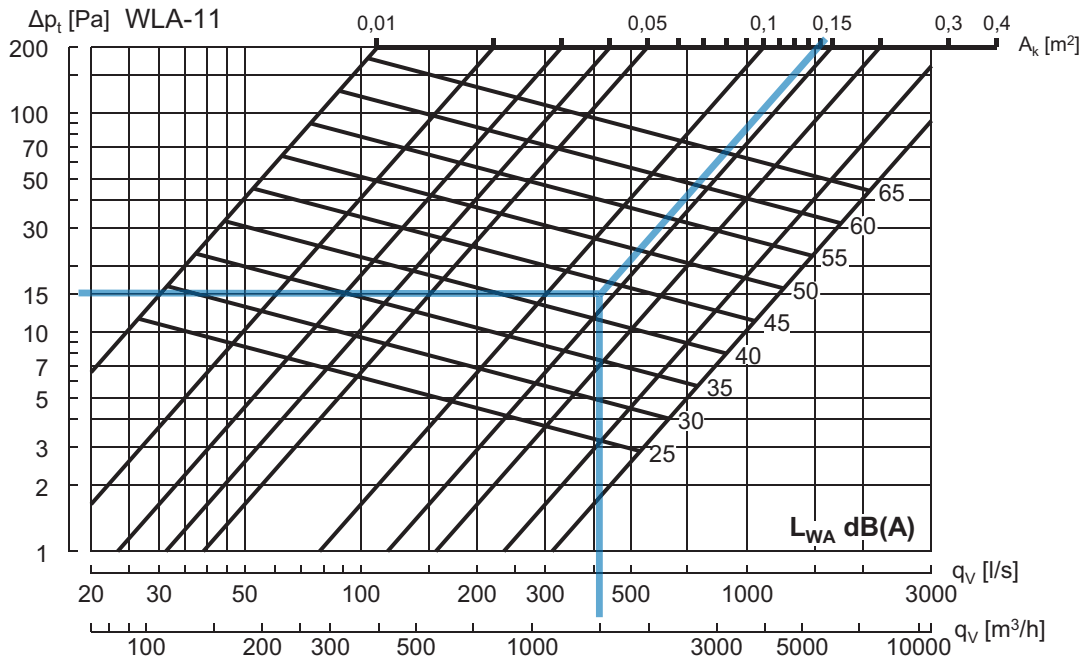

**Example: WLA-11**

Grille size (LxH): 600 x 400 mm  
 Free area  $A_k$ : 0.14 m²  
 Air flow rate  $q_v$ : 1500 m³/h (417 l/s)

**Data valid for:**

- Air intake

For grilles with free area > 0.4 m², we refer to use Lindabs online calculation tool on [www.lindqst.com](http://www.lindqst.com).

**Result:**

Sound power level  $L_{WA}$ : ~43 [dB(A)]  
 Total pressure loss  $\Delta p_t$ : ~15 [Pa]

## Technical data, WLA-22

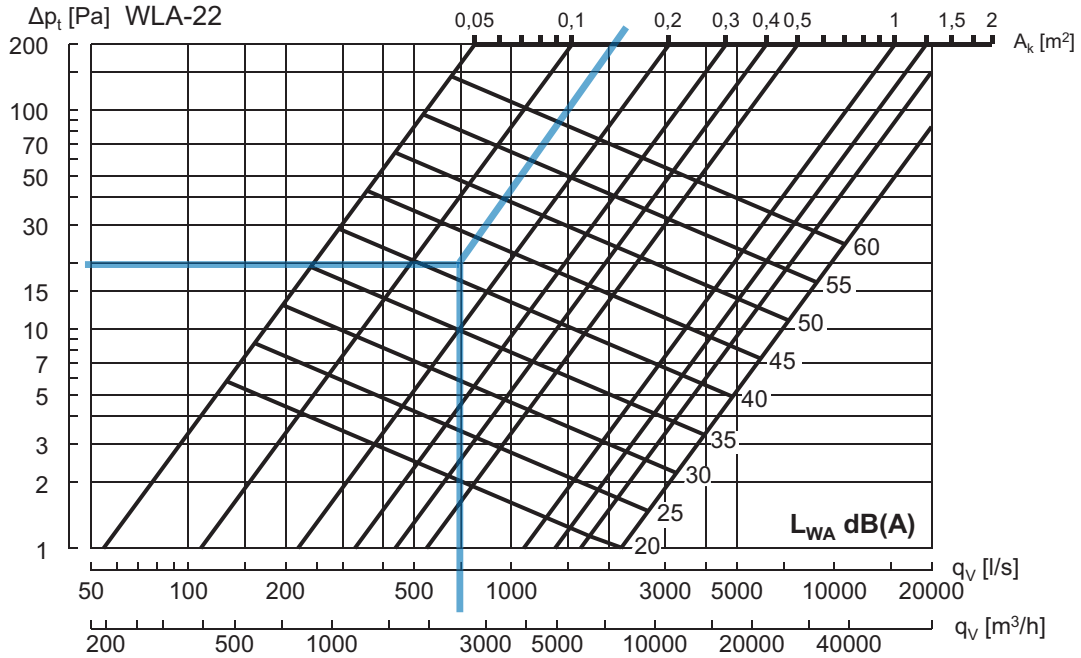

**Example: WLA-22**

Grille size (LxH): 600 x 600 mm  
 Free area  $A_k$ : 0.142 m²  
 Air flow rate  $q_v$ : 2500 m³/h (694 l/s)

**Result:**

Sound power level  $L_{WA}$ : ~42 [dB(A)]  
 Total pressure loss  $\Delta p_t$ : ~20 [Pa]

**Data valid for:**

- Air intake

For grilles with free area > 2 m², we refer to use Lindabs online calculation tool on [www.lindqst.com](http://www.lindqst.com).

# Grille

# WLA

## Technical data, WLA-33

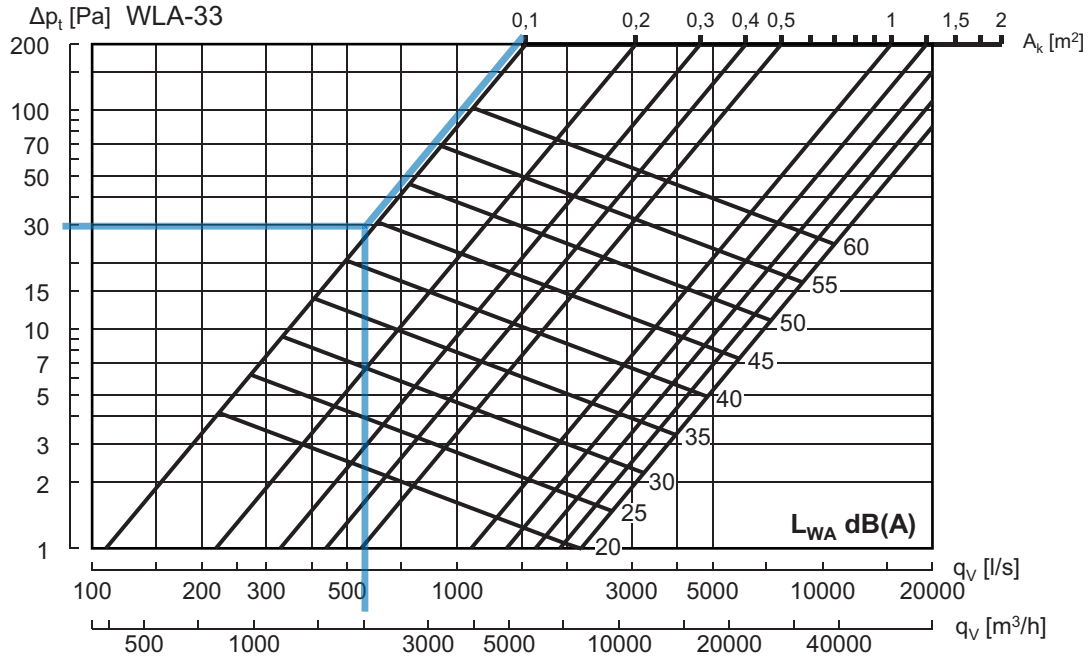

**Example: WLA-33**

Grille size (LxH): 600 x 450 mm  
 Free area  $A_k$ : 0.092  $\text{m}^2$   
 Air flow rate  $q_v$ : 2500  $\text{m}^3/\text{h}$  (694 l/s)

**Result:**

Sound power level  $L_{WA}$ : ~43 [dB(A)]  
 Total pressure loss  $\Delta p_t$ : ~30 [Pa]

**Data valid for:**

- Air intake

For grilles with free area > 2  $\text{m}^2$ , we refer to use Lindabs online calculation tool on [www.lindqst.com](http://www.lindqst.com).



Most of us spend the majority of our time indoors. Indoor climate is crucial to how we feel, how productive we are and if we stay healthy.

We at Lindab have therefore made it our most important objective to contribute to an indoor climate that improves people's lives. We do this by developing energy-efficient ventilation solutions and durable building products. We also aim to contribute to a better climate for our planet by working in a way that is sustainable for both people and the environment.

[Lindab](#) | For a better climate