

# Lindab **Roof hoods, Membrane lead-through**

Assembly instructions

# Roof hoods

H, HV, HU, HN, HF, VHL, HRR, HVR, LHR, HKOMR, TGR, TGKOMR

## Roof hoods



## Roof transitions



## Vapour membranes

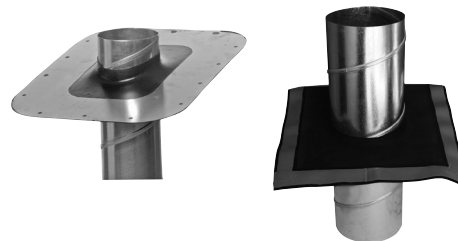

## Assembly

H, HV and HF in Ø 400–1250; HRR and HVR in sizes 7–9 and HKOMR in sizes 2–14 are equipped with three or four wire eyelets to make lifting easier. The eyelets can be turned and even used as attachments to anchor the product. An individual anchoring eyelet must not be subjected to forces in excess of 1,500 N.

## Maintenance

The hoods normally do not require any maintenance but depending on the position, regular checks that leaves or other items are not blocking the flow of air may be necessary. Regular checks of the anchoring may also be recommended.

### Connection scheme

To connect some of our roof hoods to the roof transition TGR, an adapter is needed.  
 The TGR is fixed to the roof with the profiles delivered with the TGR.

<b>Roof hood</b>	H HV HU HN HF	VHL	LHR	HRR HVR
	<b>Hoods with circular connection</b>		<b>Hoods with rectangular connection</b>	
Hood to adapter	Screw or bolt		Guiding profile	The hood is attached directly to the roof transition. – No adapter is needed.
<b>Adapter</b>	TGR-OA Ø80–315    Ø400–1250	TGR-VHL Ø100–315    Ø400–500	TGR-LHR	
Adapter to roof transition	Screw			
<b>Roof transition</b>	TGR			
Roof transition to connector	Guiding profile			
<b>Connector</b>	TGR-NA	The roof transition is attached directly to the duct. – No connector is needed.		
Connector to duct	Screw, blind rivet or Lindab Click			
<b>Duct</b>	SR	LKR		

## Membrane lead-through MG

Vapour diffusion tight membrane grommet for all types of air ducts, ventilation ducts or cables, and for roof pitches of 0° - 55°.

### Application



MG – use as wind barrier.

The EnEC prescribes that the air exchange rate due to leaks in the building envelope for buildings with ventilating and air conditions systems at 50 Pa, must not exceed the value 1.5h<sup>-1</sup> (Blower - Door - Test).

Above all it is about saving energy, but also as a result preventing moisture damage due to condensation in the insulation.

Amongst other things this requires leak tight connections and installations in the wall and roof area.

Vapour diffusion tight building component implementations are therefore indispensable in the low energy and passive house building area.

With the Lindab membrane grommets a completely leak tight implementation as a vapour barrier can be realised - both in the roof area and on the outside wall.

Lindab membrane grommets are used, where completely leak tight solutions are required to installation of air ducts, pipes or cables.

### Product description

The MG membrane grommet is made from a 1.0mm thick aluminium frame, which is integrated into a special flexible 2 component rubber membrane.

The grommet is available in various sizes for pipe diameters up to 710mm.

The membrane grommet can be glued on or screwed on.

### External

Membrane grommet

Roof support system / wind barrier

Insulation

Vapour barrier

Membrane grommet

Internal

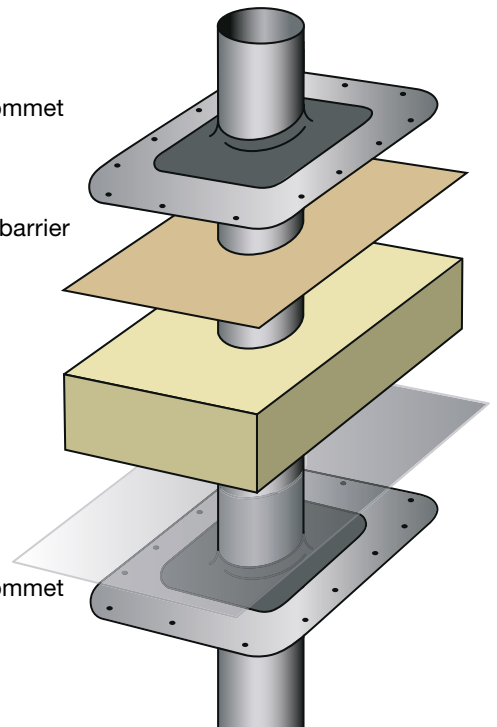

Various applications, according to roof construction.



MG application on both sides, can be used according to installation situation.

**Assembly through-roof ridge**

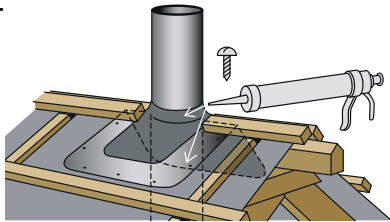

Bend the membrane grommet in the middle, stick on and screw on if necessary.

**Affix to sealing course**

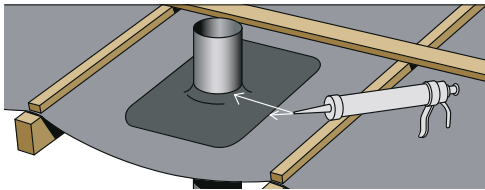

Stick on the membrane grommet.

**Assembly on fixed roof support system**

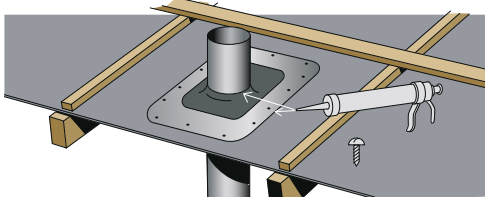

Stick on and poss. screw on the membrane grommet.

**Assembly on fixed roof support system with roofing membrane**

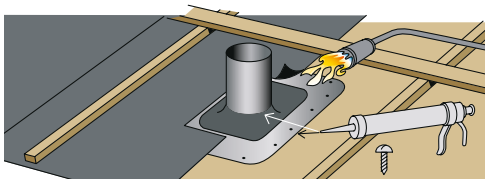

Stick on and poss. screw on the membrane grommet, before attaching the welding seam.

**Wall assembly**

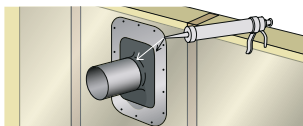

After assembly of the vapour barrier/wind barrier stick on the membrane grommet.

**Concrete or storey ceiling**

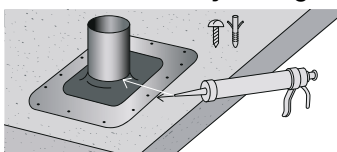

Stick on and poss. screw the membrane grommet onto the raw ceiling, before further floor construction.

**Assembly example**

The Lindab membrane grommet can be used for roof pitches of 0° to 55° without additional measures.

In the roof ridge the grommet must be bent in the middle and then adjusted to the appropriate roof pitch.

The membrane can be adjusted easily, by cutting a hole that is 20mm smaller than the size of the building component to be implemented.

The membrane can be affixed with double sided sticky tape or glue.

To attach to rigid roof support structures, concrete and/or storey roofs, screw holes are provided.

When assembling with screws the points of contact must be sealed with sealing agent.

After assembly the impact points between implemented building component and membrane, in particular in the area of pipe joints, should be jointed with sealing agent.

As an adhesive and for sealing the sealing agent cartridges with an MS polymer base that are optionally available with the membrane grommets should be used.

If the plate is rotated, the Lindab membrane grommet can be used for fixed roof support system with roofing membrane.

The roofing membrane can then be carefully welded onto the aluminium sheet.

**Advantages**

- flexible application
- quick and easy assembly
- ensures highest airtightness
- prevents structural damages due to water vapour diffusion

### Assembly sequence

1. Cut a hole 20mm smaller than the building component to be implemented (if necessary consider roof pitch).

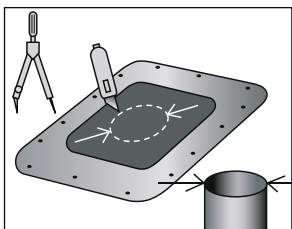

2. Coat the aluminium frame with glue.

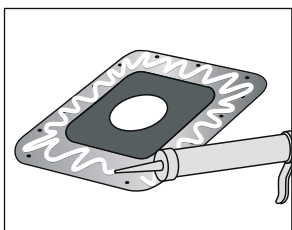

3. Pull the membrane grommet over the component.

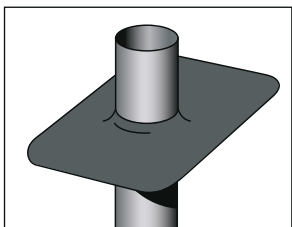

4. Glue the membrane grommet onto the connecting building component or screw on and seal.
5. If necessary seal permeation.

As an adhesive and for sealing the sealing agent cartridges with an MS polymer base that are optionally available with the membrane grommets should be used.

### Dimensions

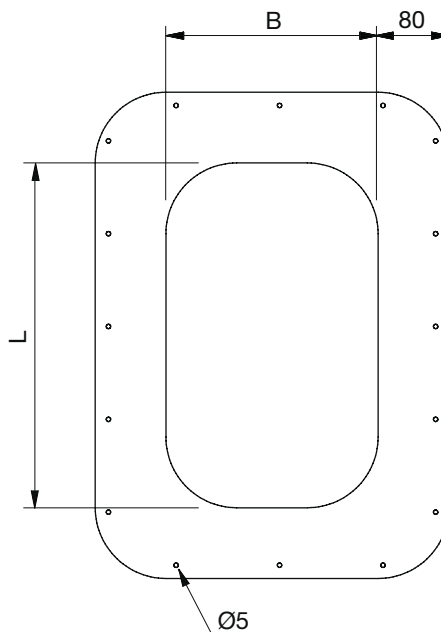

Special dimensions, can be used for 0° pitch and pipes of 100–160 diameter

Type	Max. pipe dimension	W × L × C mm	m kg
	□ / diameter mm		
MG 1016	160	200 × 200 × 50	0,32

### Standard installations

Type	Max. pipe dimension	W × L × C mm	m kg
	□ / diameter mm		
MG 100	110	150 × 235 × 80	0,40
MG 200	200	240 × 390 × 80	0,78
MG 315	315	355 × 565 × 80	1,36
MG 400	405	445 × 750 × 80	1,76
MG710	710	750 × 1280 × 80	2,00

Vapour diffusion seal, self adhesive membrane grommet for all types of building component penetrations for slight pitches.

### Application

For sealing building components which penetrate the roof or wall construction and/or the vapour barrier.

Specially for low energy and/or passive house building. Membrane grommet light - an adhesive design for a completely tight implementation of air ducts, ventilation pipes, cables or other building components up to 355mm diameter.

Membrane grommet made of special, flexible synthetic rubber with double sided adhesive strips. In particular for bonding to sheets or roofing membranes.

### Assembly

The membrane is easy to adjust; the recess is cut 20mm smaller than the building component to be implemented.

The membrane is bonded to the vapour block with the adhesive strip attached in the factory.

Only for bonding to smooth, clean surfaces.

After assembly the impact points between implemented building component and membrane, in particular in the area of pipe joints, should be jointed with sealing agent.

As an adhesive and for sealing the sealing agent cartridges with an MS polymer base that are optionally available with the membrane grommets should be used.

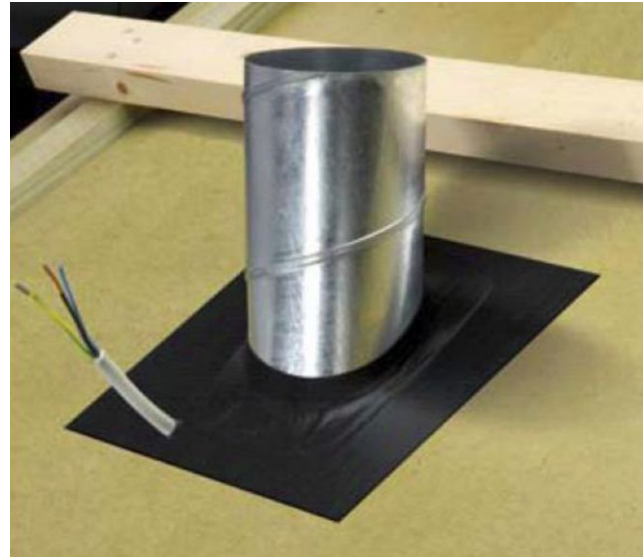

### Dimensions

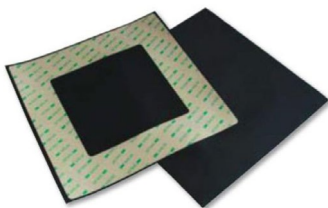
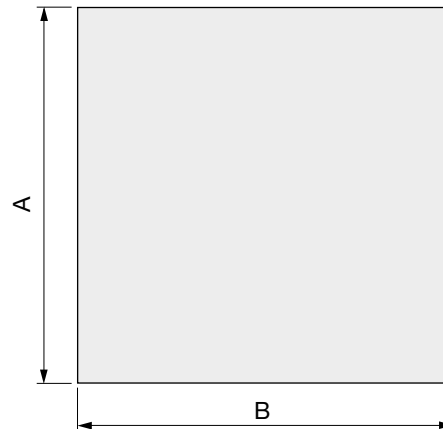

With double sided adhesive tape on one side.

### Standard installations

Type	Max. pipe dimension □ / diameter mm	W x L x C mm	m kg
MG 80	80	200 x 200	0,10
MG 125	125	250 x 250	1,10
MG 160	160	300 x 300	0,15
MG 250	250	400 x 400	0,20
MG 355	355	500 x 500	0,25



Most of us spend the majority of our time indoors. Indoor climate is crucial to how we feel, how productive we are and if we stay healthy.

We at Lindab have therefore made it our most important objective to contribute to an indoor climate that improves people's lives. We do this by developing energy-efficient ventilation solutions and durable building products. We also aim to contribute to a better climate for our planet by working in a way that is sustainable for both people and the environment.

[Lindab | For a better climate](#)